

DATASHEET APMSXXG-ULN Specification v1.69

Multi-Channel RF and MW Signal Generators

300 kHz to 6, 12, 20, 33 and 40 GHz

(Serial Number: *-***[FGL]*****-****)



Document size:

1 title page
23 content pages

DEFINITIONS

- The specifications in the following pages describe the warranted performance of the instrument for 23 ± 5 °C after a 30-minute warm-up period

Typical: Expected mean values, not warranted performance

Min and max: Parameter range that is guaranteed by product design, and/or production tested. Warranted performance specifications include guard-bands to account for the expected statistical performance distribution, measurement uncertainties, and changes in performance due to environmental conditions.

INTRODUCTION

- **A compact, 300 kHz to 6, 12, 20, 33, or 40 GHz ultra-low phase noise, 25 μ s phase coherent switching, multi-channel signal generator**

The APMSXXG-ULN is a phase-coherent, multi-channel, high output power, ultra-fast switching and ultra-low phase noise signal generator with a frequency range from 300 kHz to 6, 12, 20, 33 or 40 GHz. It is ideally suited for a wide range of applications, where good signal quality, accurate and wide output power ranges, and very stable phase coherence among all channels are required. Excellent phase noise is combined with good spurious, harmonic rejection and optionally leading-edge switching speed of 25 μ s.

A high-stability OCXO reference provides excellent frequency accuracy and stability. The generator accepts a wide range of external references including the commonly used 10 and 100 MHz for higher phase synchronization, and a flexible reference choice in the range of 1-250 MHz for those applications with customer- or system-specific reference frequencies. Moreover, the APMSXXG-ULN features a pair of ANAPICO-specific high-frequency CLK ports (one input and one output) that enables excellent phase synchronization among the outputs from multiple APMSXXG-ULN modules.

The APMSXXG-ULN comes in a standard 19 inch 1U (up to 4 channels) rack-mountable module form. It can be intuitively controlled by a PC based GUI Software. Moreover, the instrument offers various communication interfaces like USB, LAN or GPIB. Each interface allows for easy and fast communication using SCPI 1999 command set. Remote control of the instrument can be quickly attained from any host system. A customer-supplied application programming interface (API) or programming examples for Matlab, Labview, C++ and other commercially available tools make the control implementation very straightforward.

SPECIFICATIONS

Signal Specifications

PARAMETER	MIN	TYPICAL	MAX	NOTE
Frequency Range	300 kHz		6 GHz	APMS06G-ULN
	300 kHz		12 GHz	APMS12G-ULN
	300 kHz		20 GHz	APMS20G-ULN
	300 kHz		33 GHz	APMS33G-ULN
	300 kHz		40 GHz	APMS40G-ULN
Resolution		<0.001 Hz		
Phase Adjustment Range	0 deg		360 deg	individually adjustable per channel
Phase Resolution		0.1 deg		
Switching Speed		1.5 ms		after SCPI command received
CW Mode		500 μs		
Sweep / List Mode		500 μs		
		25 μs		Option FS
SSB Phase noise at 1 GHz (max output power; ALC Off)				see plots/tables
at 10 Hz from carrier		-87 dBc/Hz	-82 dBc/Hz	Option LN
at 1 kHz from carrier		-100 dBc/Hz	-96 dBc/Hz	
at 100 kHz from carrier		-130 dBc/Hz	-126 dBc/Hz	
at 100 kHz from carrier		-145 dBc/Hz	-141 dBc/Hz	
Output Power Level APMS06/12/20/33/40G				
< 100 MHz	-20 dBm		+20 dBm	
100 MHz to 6 GHz	-20 dBm		+25 dBm	
6 GHz to 18 GHz	-20 dBm		+23 dBm	
18 GHz to 20 GHz	-20 dBm		+20 dBm	
20 GHz to 40 GHz	-20 dBm		+18 dBm	
Output Power Level APMS06/12/20G				Option PE4
10 MHz to 12 GHz	-80 dBm		+20 dBm	
12 GHz to 15GHz	-80 dBm		+18 dBm	
15 GHz to 20 GHz	-80 dBm		+15 dBm	
> 20 GHz	-80 dBm		+12 dBm	
Output Power Level APMS33G/40G				Option PE4
10 MHz to 20 GHz	-50 dBm		+19 dBm	
20 to 33 GHz	-50 dBm		+16 dBm	
> 33 GHz	-50 dBm		+ 15 dBm	
Output Power: Relative Power Error (0.1 dB step) APMS06/12/20/33/40				
300 kHz to 20 GHz		< 0.1 dB	0.5 dB	-20 dBm to +15 dBm
		< 0.1 dB	0.5 dB	-50 dBm to -20 dBm (Option PE4)
		< 0.1 dB		-80 dBm to -50 dBm (Option PE4)
20 GHz to 40 GHz		< 0.1 dB		-20 dBm to +15 dBm
		< 0.1 dB		-50 dBm to -20 dBm (Option PE4)
Power Resolution		0.01 dB		
Thermal Drift		0.015 dB/°C		
Power Level Uncertainty				
< 6 GHz		0.25 dB	0.8 dB	-15 to +15 dBm
			1.2 dB	-50 to -15 dBm or > 15 dBm
6 to 12 GHz		0.3 dB	0.9 dB	-15 to +15 dBm
			1.3 dB	-50 to -15 dBm or > 15 dBm
12 to 26 GHz		0.3 dB	1.0 dB	-15 to +15 dBm
			2.0 dB	-50 to -15 dBm or > 15 dBm
26 to 40 GHz		0.4 dB	1.2 dB	-15 to +15 dBm
			2.3 dB	-45 to -15 dBm or > 15 dBm
< 26 GHz		4 dB		< -50 dBm
>26 GHz				< -45 dBm

Reverse Power Protection				
DC Voltage			±10 V	
RF Power			26 dBm	

PARAMETER	MIN	TYPICAL	MAX	NOTE
Output impedance		50 Ohms		
VSWR		1.3 1.6 1.9	1.5 1.8 2.2	< 15 GHz 15 to 35 GHz > 35 GHz
Harmonics				at +5 dBm output power
10 to 200 MHz		-30 dBc	-20 dBc	
200 MHz to 6 GHz		-40 dBc	-30 dBc	
6.5 to 12.75 GHz		-35 dBc	-30 dBc	
12.75 to 20 GHz		-45 dBc	-30 dBc	
20 to 40 GHz		-40 dBc	-30 dBc	
Sub-Harmonics				
< 5GHz		-75 dBc	-70 dBc	
5-20 GHz		-70 dBc	-65 dBc	
> 20GHz		-55 dBc		
Non-Harmonic Spurious				> 10 kHz offset
< 1.2 GHz		-90 dBc	-85 dBc	
1.2 to 2.5 GHz		-92 dBc	-88 dBc	
2.5 to 5 GHz		-87 dBc	-82 dBc	
5 to 10 GHz		-80 dBc	-75 dBc	
10 to 20 GHz		-75 dBc	-70 dBc	
20 to 40 GHz		-67 dBc		
Channel to Channel Performance				
Isolation				
< 3 GHz	90 dB			
3 to 6.5 GHz	70 dB	80 dB		
> 6 GHz		> 60 dB		
300 kHz to 40 GHz	80 dB	> 90 dB		Option HI, see plot
Relative Phase Stability				See plot
Between channels		0.096 ps		3 mrad at 5 GHz over 5 hours
Between synchronized Modules		0.160 ps		5 mrad at 5 GHz over 5 hours
Phase-Coherent Switching				
Phase mismatch at outputs		15 ps		

Modulation Capabilities

PARAMETER	MIN	TYPICAL	MAX	NOTE
Pulse Modulation				
Modulation Source		Internal/ External		
External input amplitude	TTL			
Pulse rise/fall time		10 ns		
On/off ratio		90 dB 80 dB 75 dB	80 dB 70 dB	Pout > +10 dBm, f < 6.5 GHz 6.5 to 18 GHz > 18 GHz
Pulse overshoot			10%	
Pulse delay		20 ns		
Pulse polarity		Normal, inverse		selectable
Internal pulse generator				
Repetition frequency (PRF)	0.1 Hz		50 MHz	= 1/T
Duty cycle	1 % to 99 % in 1% steps			within specified minimum pulse width
Pulse Pattern Modulation & Staggered PRF				using internal pattern generator
Pulse width	25 ns		20 s	
Programmable pattern length	2		65536	
Duty cycle	0.05%		99.95%	
Pulse width resolution		5 ns		
Pulse period (T) accuracy		0.00005xT+ 3ns		
Pulse width accuracy		0.00005xT+ 5ns		
Pulse jitter		2 ns	5 ns	
Polarity		selectable		
Amplitude Modulation				
				Option MOD
Modulation Source		Internal		
Modulation Depth	0%		90%	
Deviation accuracy		2%	4%	1 kHz rate, 30% depth, 10dBm
Deviation resolution		1%		
Distortion (THD)			1%	1 kHz rate, 30% depth, 10dBm
Modulation rate	0.1 Hz		20 kHz	
Modulation waveforms	Sine			
Frequency Modulation				
				Option MOD
Modulation source		Internal		
Maximum Frequency deviation (peak)	N · 200 MHz			< 1.25 GHz (N=1) 1.25 GHz to 2.5 GHz (N=0.125) 2.5 GHz to 5 GHz (N=0.25) 5 GHz to 10 GHz (N=0.5) 10 GHz to 20 GHz (N=1) 20 GHz to 40 GHz (N=2)
Deviation accuracy		0.50%	2%	
Distortion (THD)		< 1 %		1 kHz rate, 10 kHz deviation
Modulation rate	0.1 Hz		80 kHz	
Modulation waveforms	Sine			

PARAMETER	MIN	TYPICAL	MAX	NOTE
Phase Modulation				Option MOD
Modulation Source		Internal		
Phase deviation (peak)	0		$300 \cdot N \cdot \text{rad}$	
Deviation accuracy		0.50%	2%	
Modulation rate	0.1 Hz		80 kHz	
Modulation waveforms	Sine			
Distortion (THD)	< 1%			1 kHz rate & N x rad deviation

Sweeping Capability

PARAMETER	MIN	TYPICAL	MAX	NOTE
Sweep Parameters	Frequency, power, phase, list			
Sweep type	Linear, logarithmic, random			
Step time (t_{step})	500 μ s 25 μ s 50 μ s $\leq 70 \mu$ s		19998 s 19998 s 19998 s 19998 s	Option FS (2 sync channels) in band Option FS (3, 4 sync channels) in band Option FS cross band
Dwell time (t_{dwell})	15 μ s		9999 s	
Off time (t_{off})	15 μ s		9999 s	
Time resolution		5 ns		
Timing delay (τ_{de})		50 ns		
Transient time (τ_{inv})			15 μ s	
Timing accuracy per point		5 ns		

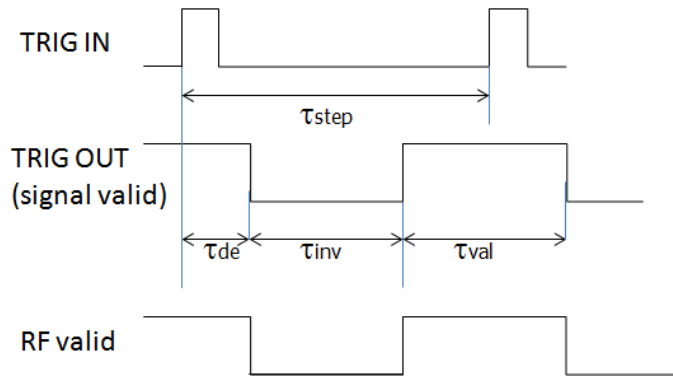

Frequency Reference

PARAMETER	MIN	TYPICAL	MAX	NOTE
Internal Reference Frequency		100 MHz 10 MHz		Option LN
Temperature stability 0 to 50 degC			±100 ppb ±20 ppb	Option LN
Aging 1st year			1000 ppb 30 ppb 20 ppb	Option LN Option LN+
Aging per day			5 ppb 0.5 ppb	after 30 days operations Option LN
Warm-up time		5 min		
Output of internal reference		10 MHz 100 MHz		REF OUT port, selectable
Output of High Frequency Clock		3 GHz		CLK OUT port high phase synchronous mode
Output power		0 dBm 9 dBm		10 MHz, 3 GHz 100 MHz
Output impedance		50 Ohms		
Bypass Internal Reference Input		100, 1000 MHz		*Options LN/LN+ are bypassed
Phase Lock to External Reference	1 MHz	10 MHz integer MHz	250 MHz	REF IN port Option VREF *Options LN/LN+ are bypassed
High Frequency Clock Input (Bypass Internal Reference)		3 GHz		CLK IN port high phase synchronous mode
Reference input level				
10 MHz or 1-250 MHz or 3 GHz	-5 dBm	0 dBm	+10 dBm	
100, 1000 MHz	+5 dBm		+13 dBm	
Lock Range				
10 MHz or 1-250 MHz			±1.5 ppm	
100 MHz			100 ppm	
Reference Input Impedance		50 Ohms		

Trigger (TRIG IN)

PARAMETER	MIN	TYPICAL	MAX	NOTE
Trigger Types		Continuous Single (point) Gated Gated direction		
Trigger Source		External Bus (LAN, USB)		
Trigger Modes		Continuous free run Trigger and run Reset and run		
Trigger latency		5 ns		
Trigger uncertainty		10 ns		
External trigger delay	50 ns		40 s	settable
External delay resolution		5 ns		
Trigger Modulo	1		255	execute only on Nth trigger event
Trigger Polarity		Rising Falling		

Phase Noise with and without Option LN (at 1 GHz and max. output power)

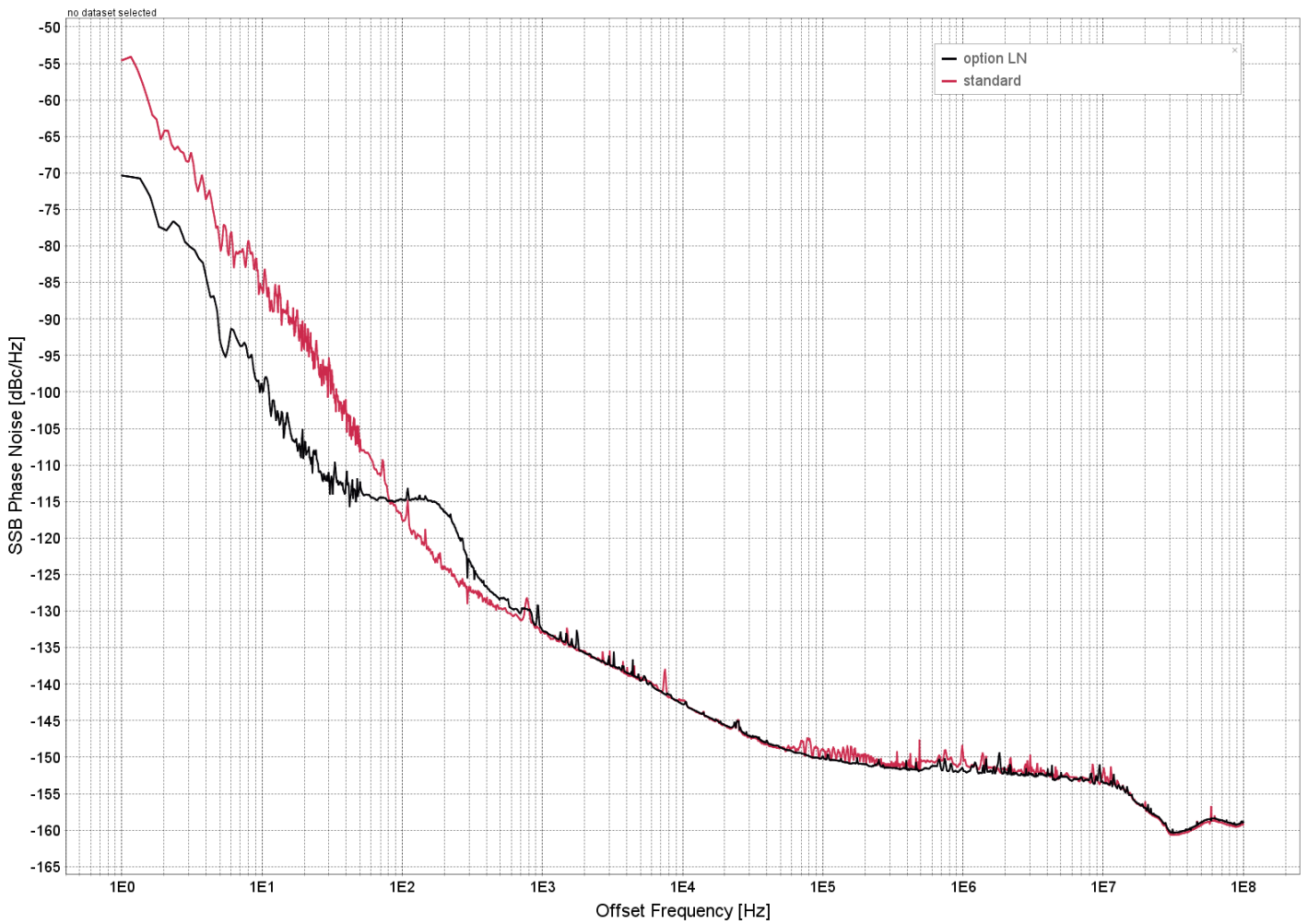

Phase Noise without Option LN (at max. output power)

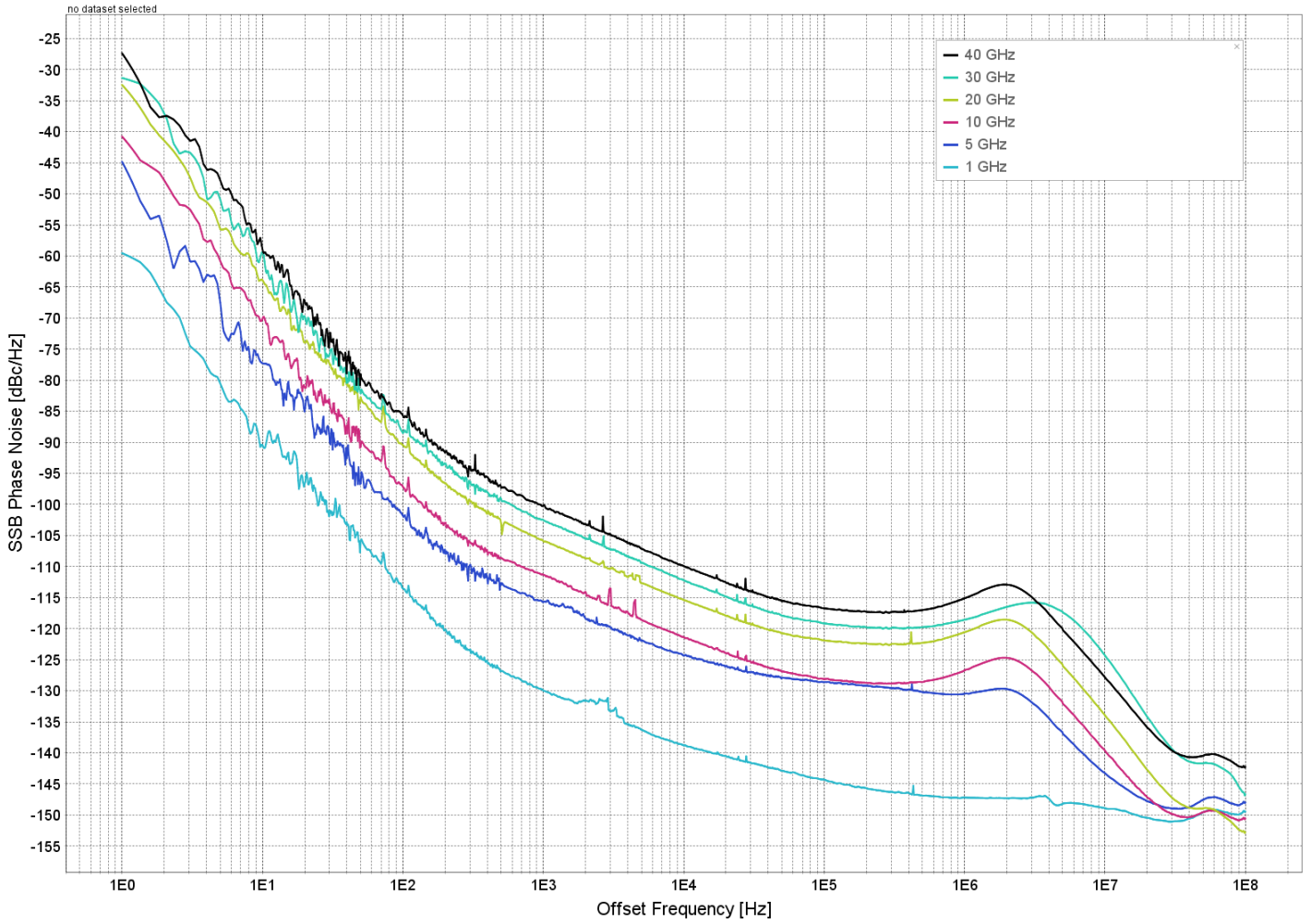

Maximum Output Power APMS20G with and without Option PE4

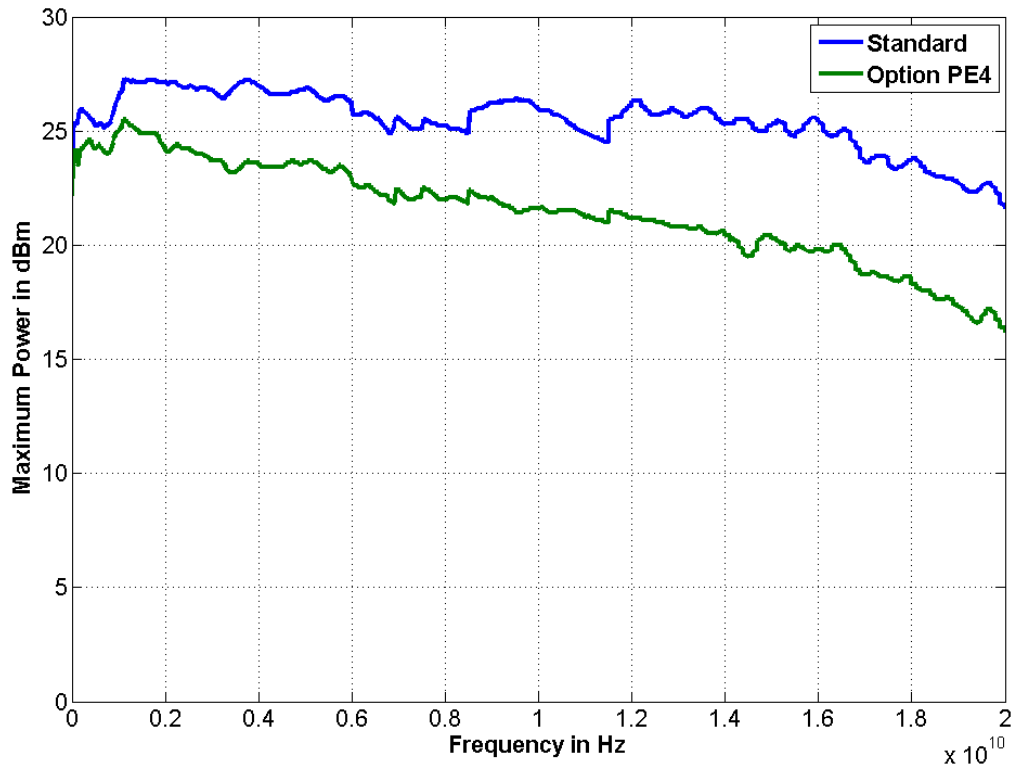

Maximum Output Power APMS40G with and without Option PE4

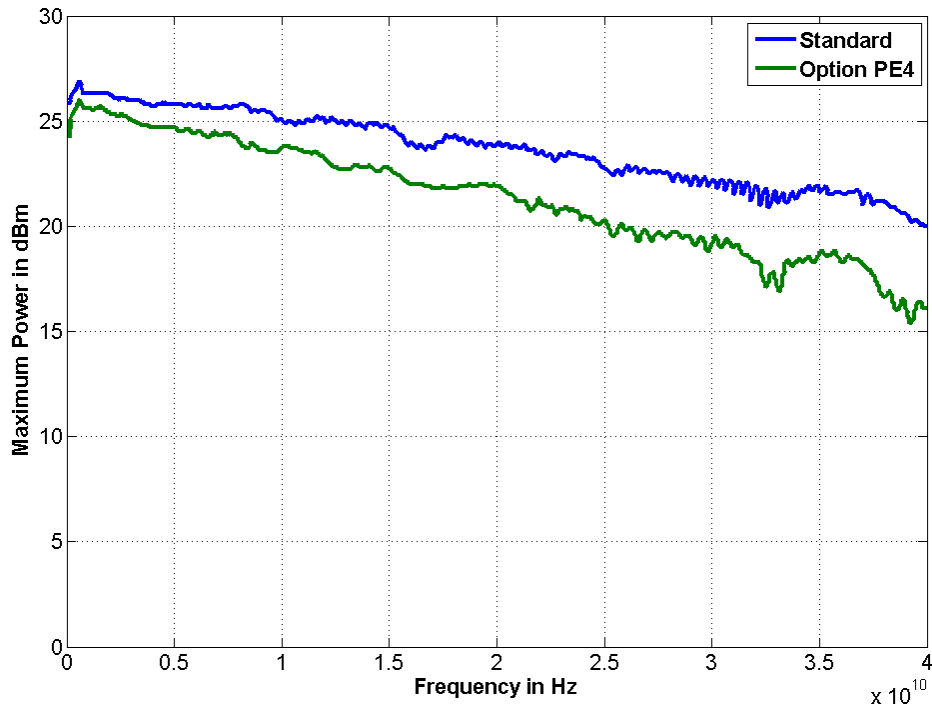

Low Frequency Response APMS20G (100 kHz to 100 MHz)

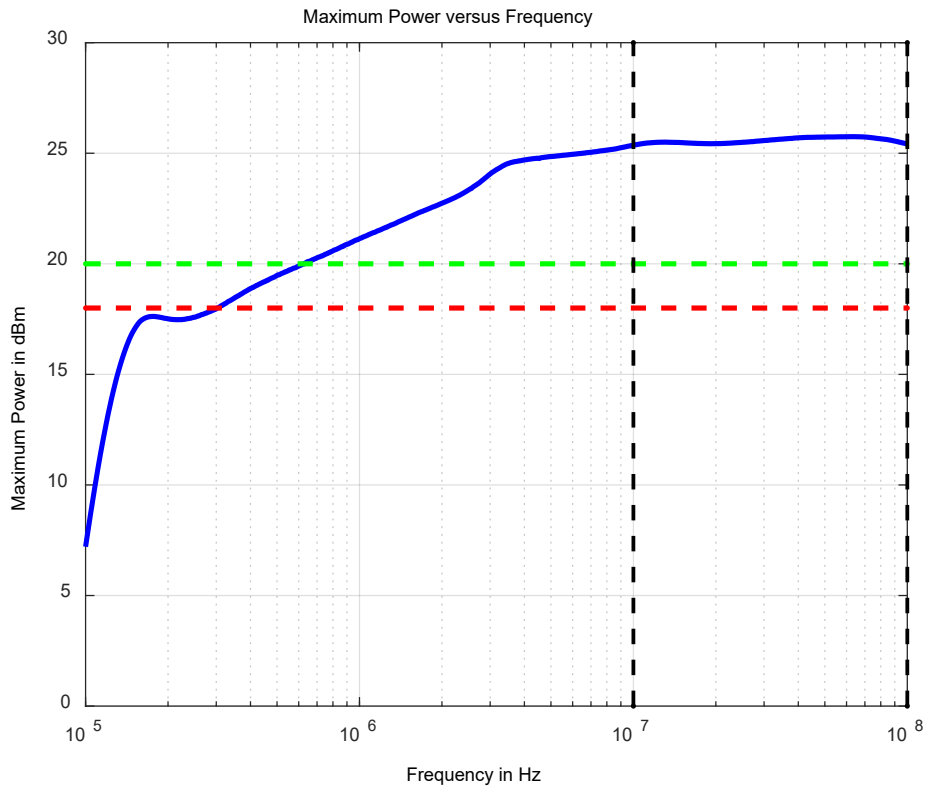

Level Error (300 kHz to 40 GHz, APMS40G)

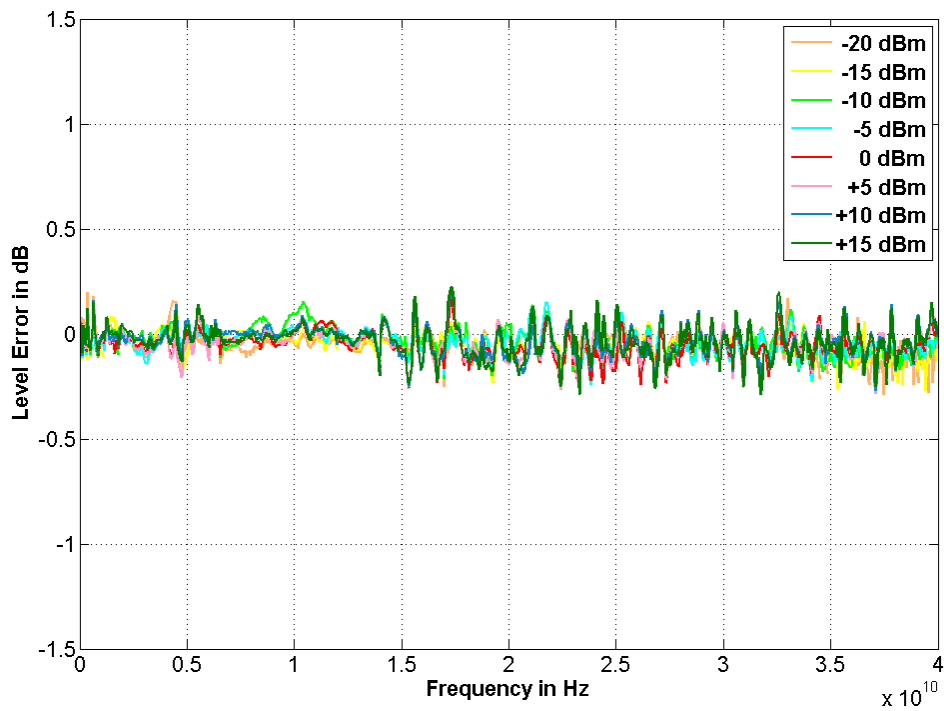

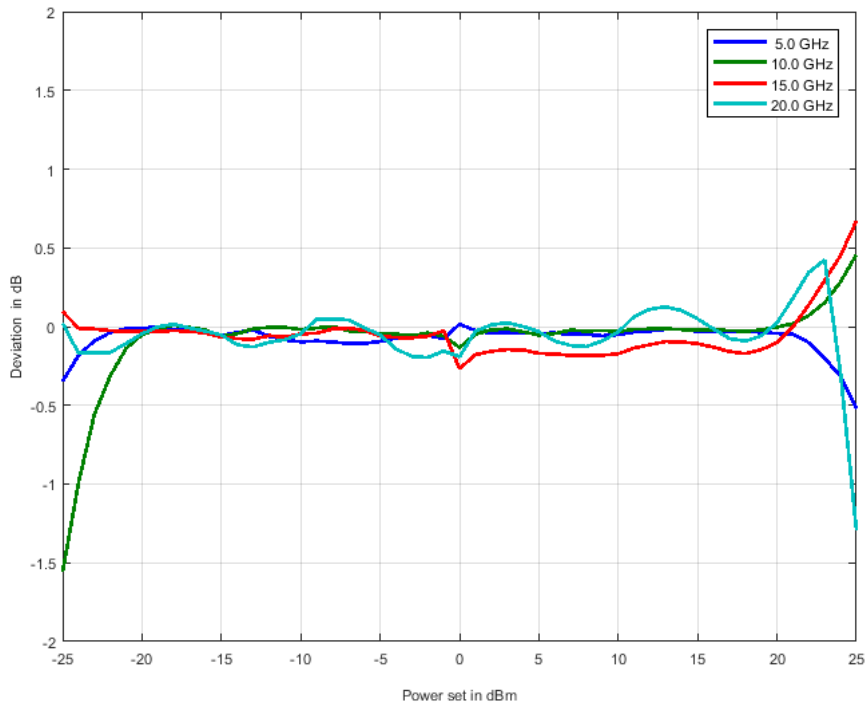

 Level Linearity with option PE4





Channel-to-Channel Isolation with Option HI

(Channel under test: Channel 1, frequency f , power 10 dBm)

Channel 2, 3 and 4: frequency $f + 9$ MHz, power 10 dBm

Measurement made on channel 1 at frequency $f + 9$ MHz)

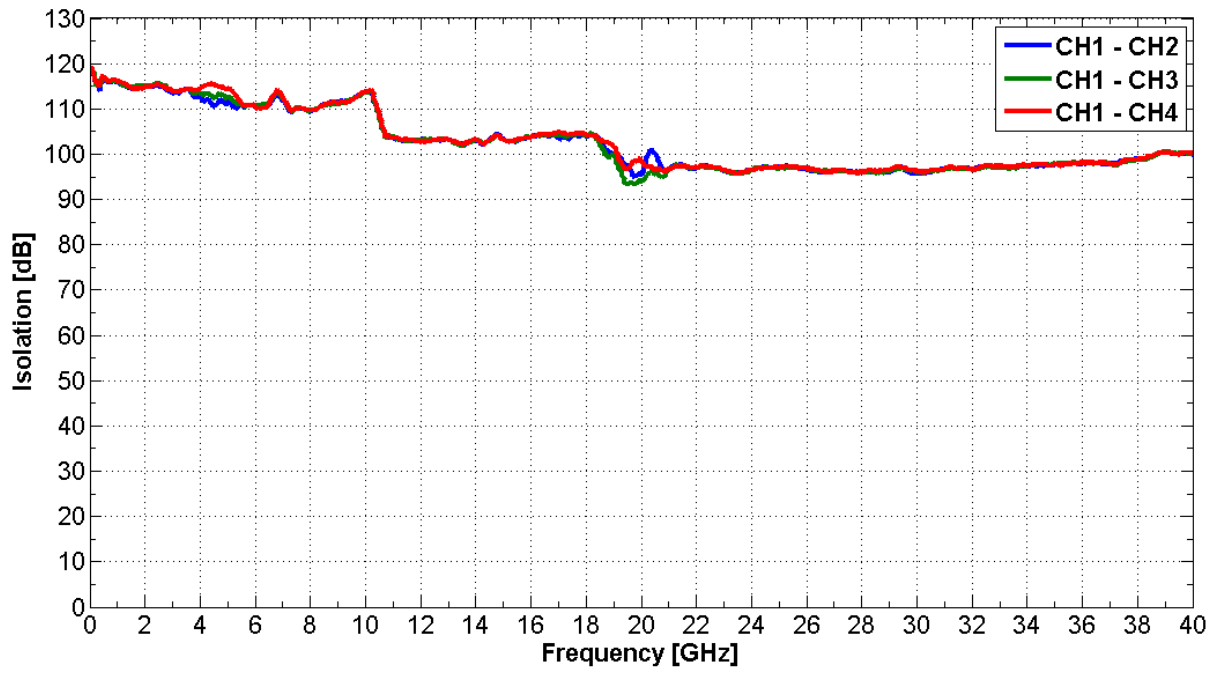

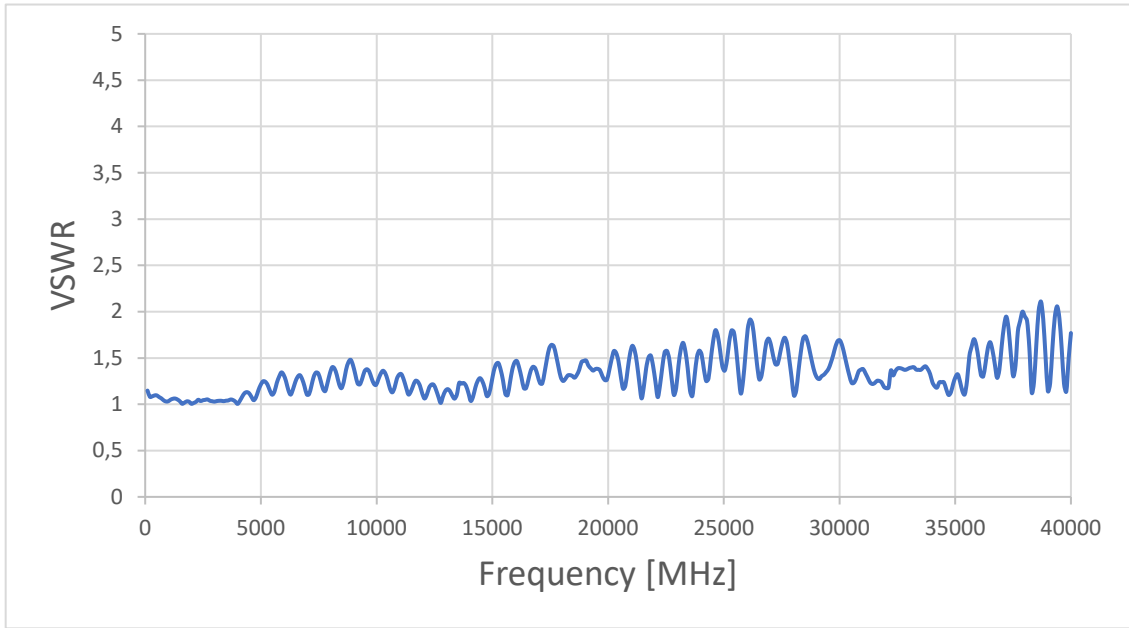

 Channel-to-Channel Phase Stability under Different Test Conditions

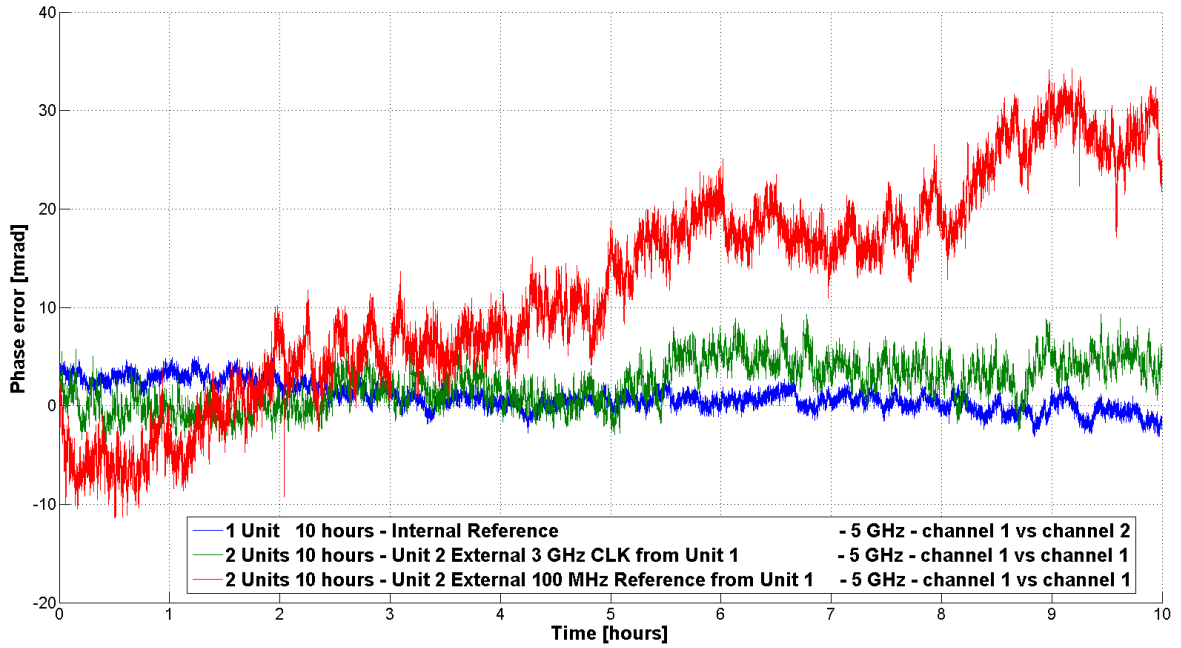

Connectors (Front)



- RF outputs:
 - APMS33G, 40G: K (2.92 mm) female
 - APMS06G, 12G, 20G: SMA female
- External pulse modulation inputs: BNC female
- DC power switch

Connectors (Rear)



- Unit-to-unit synchronization signal input (SYNC IN): SMA female
- Unit-to-unit synchronization signal output (SYNC OUT): SMA female
- High Stability Reference input (CLK IN, 3 GHz): SMA female
- High Stability Reference output (CLK OUT, 3 GHz): SMA female
- Trigger output: BNC female
- Trigger input: BNC female
- Reference output (REF OUT): BNC female
- Reference input (REF IN): BNC female
- GPIB: IEEE-488.2, 1987 with listen and talk (optional)
- USB 2.0 device
- LAN connection: RJ-45
- FUSE (3.15 A)
- 100-240V AC power plug

 Casings Standard 19" 1HU



High Isolation Casing 19" 1HU (Option HI, rack mount kit included)



ORDERING INFORMATION



Host Model No.	Product	Description
APMSXXG-ULN	APMS06G-2-ULN	2-channel 300 kHz to 6 GHz ultra-low phase noise, fast switching signal generator, 19" 1HU rack-mount module
APMSXXG-ULN	APMS06G-3-ULN	3-channel 300 kHz to 6 GHz ultra-low phase noise, fast switching signal generator, 19" 1HU rack-mount module
APMSXXG-ULN	APMS06G-4-ULN	4-channel 300 kHz to 6 GHz ultra-low phase noise, fast switching signal generator, 19" 1HU rack-mount module
APMSXXG-ULN	APMS12G-2-ULN	2-channel 300 kHz to 12 GHz ultra-low phase noise, fast switching signal generator, 19" 1HU rack-mount module
APMSXXG-ULN	APMS12G-3-ULN	3-channel 300 kHz to 12 GHz ultra-low phase noise, fast switching signal generator, 19" 1HU rack-mount module
APMSXXG-ULN	APMS12G-4-ULN	4-channel 300 kHz to 12 GHz ultra-low phase noise, fast switching signal generator, 19" 1HU rack-mount module
APMSXXG-ULN	APMS20G-2-ULN	2-channel 300 kHz to 20 GHz ultra-low phase noise, fast switching signal generator, 19" 1HU rack-mount module
APMSXXG-ULN	APMS20G-3-ULN	3-channel 300 kHz to 20 GHz ultra-low phase noise, fast switching signal generator, 19" 1HU rack-mount module
APMSXXG-ULN	APMS20G-4-ULN	4-channel 300 kHz to 20 GHz ultra-low phase noise, fast switching signal generator, 19" 1HU rack-mount module
APMSXXG-ULN	APMS33G-2-ULN	2-channel 300 kHz to 33 GHz ultra-low phase noise, fast switching signal generator, 19" 1HU rack-mount module
APMSXXG-ULN	APMS33G-3-ULN	3-channel 300 kHz to 33 GHz ultra-low phase noise, fast switching signal generator, 19" 1HU rack-mount module
APMSXXG-ULN	APMS33G-4-ULN	4-channel 300 kHz to 33 GHz ultra-low phase noise, fast switching signal generator, 19" 1HU rack-mount module
APMSXXG-ULN	APMS40G-2-ULN	2-channel 300 kHz to 40 GHz ultra-low phase noise, fast switching signal generator, 19" 1HU rack-mount module
APMSXXG-ULN	APMS40G-3-ULN	3-channel 300 kHz to 40 GHz ultra-low phase noise, fast switching signal generator, 19" 1HU rack-mount module
APMSXXG-ULN	APMS40G-4-ULN	4-channel 300 kHz to 40 GHz ultra-low phase noise, fast switching signal generator, 19" 1HU rack-mount module
APMSXXG	option LN	Enhanced close in phase noise and frequency stability
APMSXXG	option LN+	Option LN with improved long term frequency stability
APMSXXG	option FLASH	MicroSD card slot for removable SD memory
APMSXXG	option PHS	Phase coherent switching
APMSXXG	option FS	Ultra-fast switching speed
APMSXXG	option VREF	Flexible external reference frequency support in range 1 to 250 MHz
APMSXXG	option MOD	Amplitude, Frequency, Phase modulations added.
APMS06/12G	option PE4-12	Electrical step attenuator (6 & 12 GHz version)
APMS20G	option PE4-20	Electrical step attenuator (20 GHz version)
APMS33/40G	option PE4-40	Electrical step attenuator (33 & 40 GHz version)

APMSXXG	option GPIB	GPIB interface
APMSXXG	option HI	High Isolation 19" 1HU casing (highly improved channel-to-channel isolation)
APMSXXG	option WE	One-year warranty extension (standard: 2 years)
APMSXXG	option ReCal	Recalibration with test data (recommended: 2 years interval)
APMSXXG	option DATA	Commercial Calibration Certificate with test data (per channel)
APMSXXG	option IEC	IEC 17025 Calibration with Certificate
APMSXXG	option Retrofit	Applies when options are back-ordered

GENERAL CHARACTERISTICS

Remote programming interfaces:

Ethernet 100BaseT LAN interface
USB 2.0 device
GPIB (IEEE-488.2,1987) with listen and talk (Option GPIB)
Control Language SCPI Version 1999.0

Power requirements: 100 - 240 VAC, 50 or 60 Hz, 160W maximum (80W + 20W per channel)

Environmental: Levels similar to MIL-PRF-28800F Class 3/4



Safety / EMC comply with applicable Safety and EMC regulations and directives.

Weight: ≤ 10.0 kg (21 lbs) net

Dimensions: 19" 1HE enclosure

APMS06/12/20G: 44 mm H x 426 mm W x 465 mm L [1.7 in H x 16.8 in W x 18.3 in L]

APMS33/40G: 44 mm H x 426 mm W x 485 mm L [1.7 in H x 16.8 in W x 19.1 in L]

Dimensions: 19" 1HE HI enclosure

44 mm H x 440 mm W x 470 mm L [1.7 in H x 17.3 in W x 18.5 in L]



Document History

Version	Date	Author	Notes
V10	2015-06-15	jk	First release
V1.01	2015-08-15	jk	Updated power ranges
V1.02	2015-09-15	jk	Added harmonic and spurious specs
V1.10	2016-02-15	jk	Refined parameters
V1.11	2016-02-22	jk	Added phase noise plot
V1.20	2016-04-08	jk	Pictures, Sweeping and Trigger information, Dimensions, Options
V1.21	2016-07-12	sd	Replaced pictures with higher resolution
V1.30	2016-07-18	jk	Additional performance data
V1.31	2016-12-02	jk	Added pictures
V1.32	2017-1-09	jk	Frequency stability information added harmonic specs refined
V1.40	2017-2-19	jk	Production release
V1.41	2017-5-30	jk	Power level accuracy refined, phase stability specified
V1.42	2017-7-27	jk	Intra-Pulse Modulation
V1.43	2017-10-27	jk	Updates for 20 GHz model
V1.45	2017-12-5	jk	Updates for 20 GHz model
V1.50	2018-2-5	jk	Updates for option ULN; PHS, IPM
V1.51	2018-3-15	jk	Mode updates on option ULN
V1.52	2018-4-5	jk	Added parameters for reference section
V1.53	2018-5-15	jk	New plots
V1.54	2018-6-25	jk	Ch to ch isolation, phase stability specs
V1.55	2018-7-25	jk	Ref input
V1.56	2018-10-18	MH	Ref inputs / outputs, SYSREF, ordering information
V1.57	2019-02-28	MH	New layout Added option LN and option FS
V1.58	2019-03-07	MH	Corrected Harmonic Values < 200MHz, APMS33/40G enclosure dimensions
V1.59	2019-04-08	MH	Added power consumption, edited Options
v.1.60	2019-05-11	MH	ULN only
v.1.61	2019-06-24	MH	Corrected connectors description
v.1.62	2020-11-23	MH	Changed reference output options, updated phase noise plots, added option HI
v.1.64	2020-12-07	MH	Added Channel-to-channel phase stability in picoseconds
v.1.65	2021-01-20	MH	Updated pulse width, option MOD (adds AM, FM and Phase Mod capability), added option LN+
v.1.68	2022-08-08	MH	Added PE Linearity spec/ updated PE values, switching speed, 10MHz Ref bypass info
v.1.69	2022-11-21	MH	Added indication for which serial number the data sheet applies



Vicom Australia

1064 Centre Road, Oakleigh
South, Victoria 3167
1300 360 251
info@vicom.com.au

Vicom New Zealand

Gnd Floor, 60 Grafton Road,
Grafton, Auckland 1010
+46 9-379 4596
info@vicom.co.nz

www.vicom.com.au
www.vicom.co.nz

