

2460 SourceMeter® SMU Instrument

Datasheet



KEITHLEY
A Tektronix Company

The 2460 High Current SourceMeter® Source Measure Unit (SMU) Instrument brings advanced Touch, Test, Invent® technology right to your fingertips. It combines an innovative graphical user interface (GUI) with capacitive touchscreen technology to make testing intuitive and minimize the learning curve to help engineers and scientists learn faster, work smarter, and invent easier. With its 7A DC and pulse current capability, the 2460 is optimized for characterizing and testing high power materials, devices, and modules such as silicon carbide (SiC), gallium nitride (GaN), DC-DC converters, power MOSFETs, solar cells and panels, LEDs and lighting systems, electrochemical cells and batteries, and much more. These new capabilities, combined with Keithley's decades of expertise in developing high precision, high accuracy SMU instruments, will make the 2460 a "go-to instrument" for high current applications in the lab and in the rack for years to come.

Key Features

- One tightly coupled instrument that combines capabilities from analyzers, curve tracers, and I-V systems at a fraction of their cost
- Wide coverage up to 105 V, 7 A DC/7 A pulse, 100 W max.
- Five-inch, high resolution capacitive touchscreen GUI
- 0.012% basic measure accuracy with 6½-digit resolution
- Source and sink (4-quadrant) operation
- Four "Quickset" modes for fast setup and measurements
- Context-sensitive help function
- Front panel input banana jacks; rear panel input mass termination screw connections
- 2460 SCPI and TSP® scripting programming modes
- Front-panel USB 2.0 memory I/O port for transferring data, test scripts, or test configurations

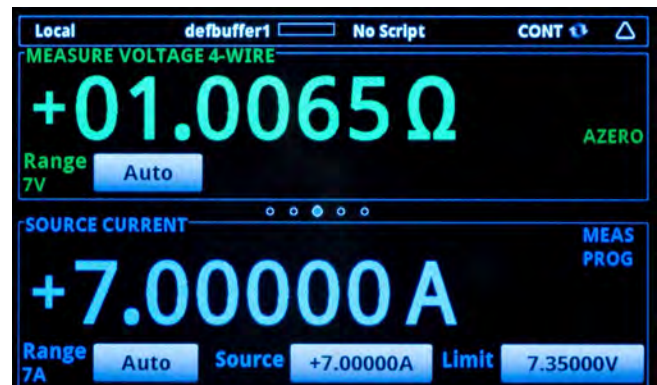

2460 main home screen.

Learn Faster, Work Smarter, Invent Easier

The 2460 features a five-inch, full-color, high resolution touchscreen that supports intuitive operation, helps operators become familiar with the instrument quickly, and optimizes overall speed and productivity. A simple icon-based menu structure reduces the number of steps required to configure a test by as much as 50 percent and eliminates the cumbersome multi-layer menu structures typically used on soft-key instruments. Built-in, context-sensitive help supports intuitive operation and minimizes the need to review a separate manual. These capabilities, combined with the 2460's high versatility, simplify its operation in both basic and advanced measurement applications, regardless of the user's previous experience in working with SMU instruments.

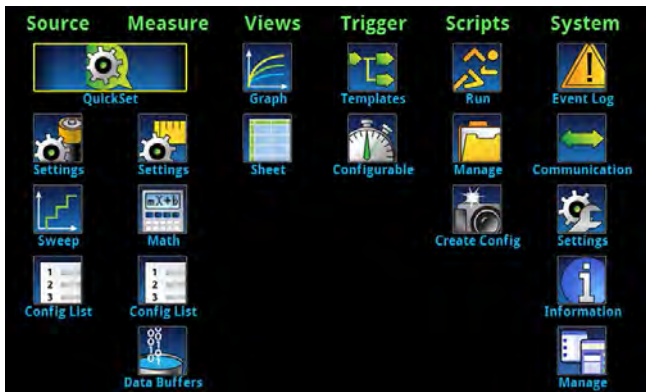

Model 2460 icon-based menu.

All-in-One SMU Instrument

The 2460, built on the fourth generation of the award-winning SourceMeter SMU platform, leverages the proven capabilities of previously introduced high current SMU instruments from Keithley, including the 2420, 2425, and 2440. It offers a highly flexible, four-quadrant voltage and current source/load coupled with precision voltage and current measurements. This all-in-one instrument gives you the capabilities of a:

- Precision power supply with V and I readback
- True current source
- Digital multimeter (DCV, DCI, ohms, and power with 6½-digit resolution)
- Precision electronic load
- Trigger controller

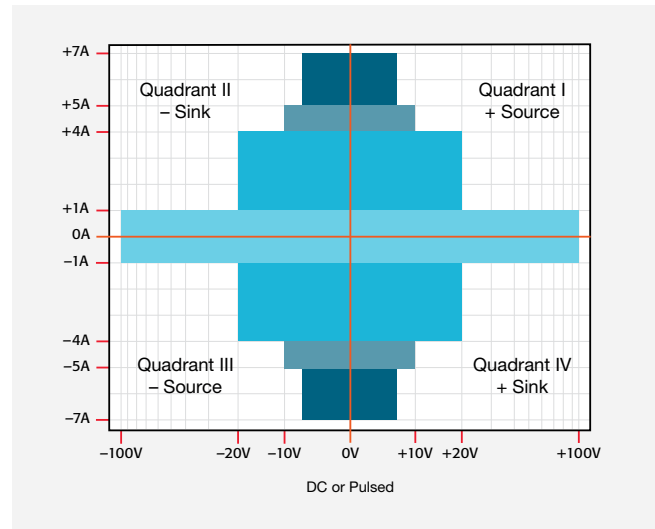

2460 power envelope.

Comparison Table: 2420, 2425, and 2440 with 2460

2420/2425/2440	2460
Max Voltage: 60 V/100 V/40 V	Max Voltage: 100 V
Max Current: 3 A/3 A/5 A	Max Current: 7 A
DC Power: 60 W/100 W/50 W	DC Power: 100 W
Wideband Noise: 10 mV rms typ.	Wideband Noise: 2 mV rms typ.
Sweep Types: Linear, Log, Custom, Source-Memory	Sweep Types: Linear, Log, Dual Linear, Dual Log, Custom
5000 Point Reading Buffer	>250,000 Point Reading Buffer
>2000 Readings/second	>3000 Readings/second
SCPI Programming	SCPI Programming + TSP Scripting
GPIB, RS-232	GPIB, USB, Ethernet (LXI)
Front/Rear Banana Jacks	Front: Banana Jacks. Rear: Mass Screw Terminal Connection



2460 front panel with high-resolution, capacitive touchscreen.

Ease of Use Beyond the Touchscreen

In addition to its advanced touchscreen, the 2460's front panel offers a variety of features that enhance its speed, user-friendliness, and learnability, including a USB 2.0 memory I/O port, a HELP key, a rotary navigation/control knob, a front/rear input selector button, and banana jacks for basic bench applications. The USB 2.0 memory port simplifies storing test results and instrument configurations, uploading test scripts into the instrument, and installing system upgrades. All front-panel buttons are backlit to enhance visibility in low-light environments.

Four "Quickset" modes simplify instrument setup. With one touch, the instrument can be quickly configured for various operating modes without the need to configure the instrument indirectly for this operation.

Comprehensive Built-in Connectivity

Rear panel access to rear-input mass termination connector, remote control interfaces (GPIB, USB 2.0, and LXI/Ethernet), D-sub 9-pin digital I/O port (for internal/external trigger signals and handler control), instrument interlock control, and TSP-Link® jacks make it simple to configure multiple instrument test solutions and eliminate the need to invest in additional adapter accessories.

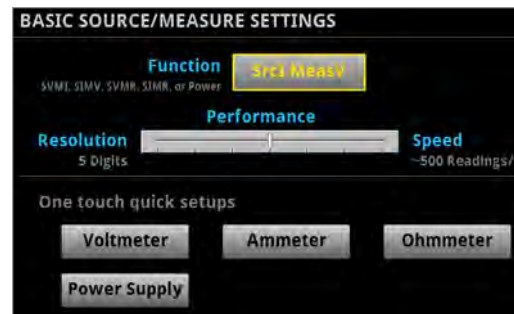

One-touch Quickset modes speed measurement setups and minimize the time to measurements.

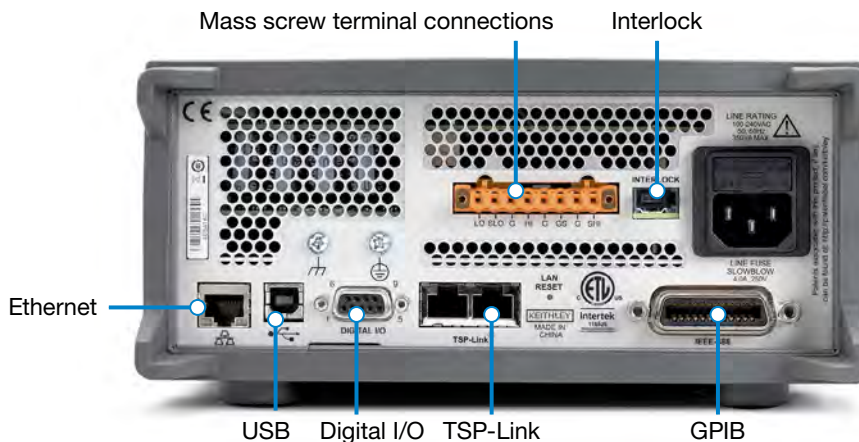

Rear panel connections are optimized for signal integrity and speed system setup

Convert Raw Data to Information

A full graphical plotting window converts raw data and displays it immediately as useful information, such as semiconductor I-V curves and voltammograms. Using the 2460's Sheet view, test data can also be displayed in tabular form. The instrument supports exporting data to a spreadsheet for further analysis, dramatically improving productivity for research, benchtop testing, device qualification, and debugging.

TriggerFlow® Building Blocks for Instrument Control and Execution

The 2460 incorporates Keithley's TriggerFlow triggering system, which provides user control over instrument execution. TriggerFlow diagrams are created in much the same way that flow charts are developed, using four fundamental building block types:

- Wait – Waits for an event to occur before the flow continues
- Branch – Branches when a condition has been satisfied
- Action – Initiates an action in the instrument, for example, measure, source, delay, set digital I/O, etc.
- Notify – Notifies other equipment that an event has occurred

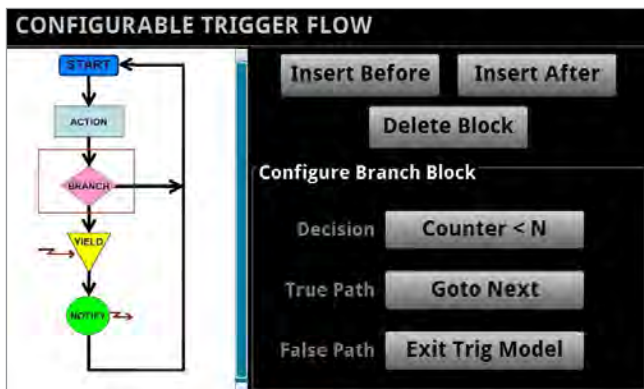

TriggerFlow building blocks allow creating triggering models that range from very simple to highly complex.

A TriggerFlow model using a combination of these building blocks can be created from the front panel or by sending remote commands. With the TriggerFlow system, users can build triggering models from very simple to complex with up to 255 block levels. The 2460 also includes basic triggering functions, including immediate, timer, and manual triggering.

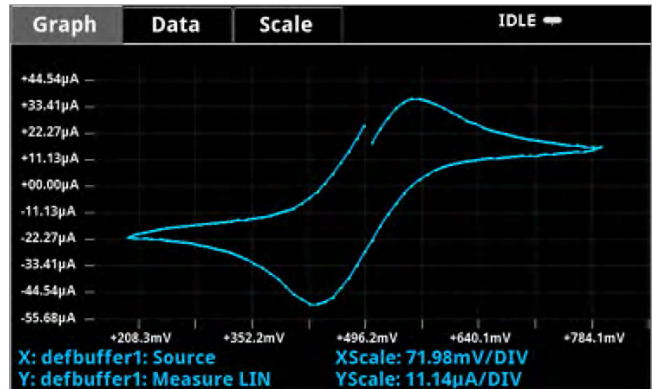
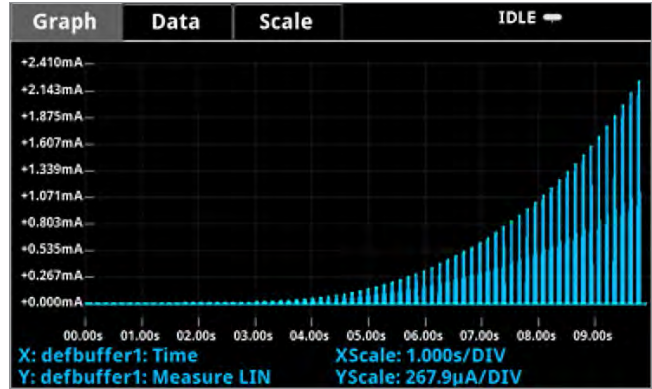

DATA SHEET

Buffer: defbuffer1 Jump to Refresh

	Time	Source	Measure
1	08:27 10:32	+7.000000 A	+01.0054 Ω
2	10:32:43.5	+7.000000 A	+01.0054 Ω
3	10:32:43.6	+7.000000 A	+01.0054 Ω
4	10:32:43.8	+7.000000 A	+01.0054 Ω
5	10:32:43.9	+7.000000 A	+01.0054 Ω
6	10:32:44.1	+7.000000 A	+01.0054 Ω
7	10:32:44.2	+7.000000 A	+01.0054 Ω
8	10:32:44.4	+7.000000 A	+01.0054 Ω
9	10:32:44.5	+7.000000 A	+01.0054 Ω

Built-in data display, charting, and spreadsheet export functions simplify converting test results into useful information.

Typical Applications

Ideal for current/voltage characterization and functional test of a wide range of modern electronic devices:

- Power semiconductors and materials
 - SiC, GaN
 - IGBTs
 - Power MOSFETs
 - Thyristors
- Power devices
 - Telecom power management chipsets
 - DC-DC converters
- Electrochemistry
 - Battery charge/discharge cycling
 - Cyclic voltammetry
 - Electro-deposition
- Energy generation
 - Solar cells
 - Batteries
- Efficient energy consumption
 - LEDs/AMOLEDs
 - Automotive modules
 - Power management modules

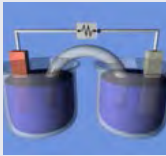

Unmatched System Integration and Programming Flexibility

When a 2460 is configured into a multi-channel I-V test system, its embedded Test Script Processor (TSP®) allows it to run test scripts, so users can create powerful measurement applications with significantly reduced development times. TSP technology also offers channel expansion without a mainframe. Keithley's TSP-Link® channel expansion bus, which uses a 100 Base T Ethernet cable, can connect multiple 2460s and other TSP instruments such as Keithley's 2450 SourceMeter SMU Instruments, Series 2600B System SourceMeter SMU instruments, and Series 3700A Switch/Multimeter systems in a master-slave configuration that operates as one integrated system. The TSP-Link expansion bus supports up to 32 units per GPIB or IP address, making it easy to scale a system to fit an application's particular requirements. The 2460 also includes a SCPI programming mode that takes advantage of all of the instrument's capabilities.

Parallel Test Capability

The TSP technology in the 2460 supports testing multiple devices in parallel to meet the needs of device research, advanced semiconductor lab applications, and even high throughput production test. This parallel testing capability allows each instrument in the system to run its own complete test sequence, creating a fully multi-threaded test environment. The number of tests that can be run in parallel on a 2460 can be as high as the number of instruments in the system.

Free Instrument Control Start-up Software

The 2460 comes with KickStart instrument control/start-up software, which lets users start taking measurements in minutes without programming. In most cases, users merely need to make some quick measurements, graph the data, and store the data to disk for later analysis in software environments such as Excel. KickStart offers:

- Instrument configuration control to perform I-V characterization
- Native X-Y graphing, panning, and zooming
- Spreadsheet/tabular viewing of data
- Saving and exporting data for further analysis
- Saving of test setups
- Screenshot capturing of graph
- Annotation of tests
- Command line dialog for sending and receiving data
- HTML help
- GPIB, USB 2.0, Ethernet compliance

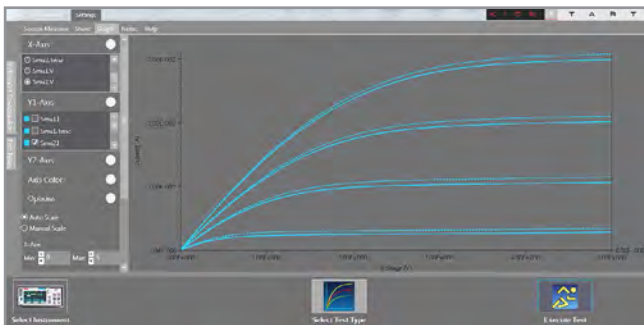

KickStart start-up software lets users be ready to take measurements in minutes.

Simplified Programming with Ready-to-Use Instrument Drivers

For those who prefer to create their own customized application software, native National Instruments LabVIEW® drivers, as well as IVI-C and IVI-COM drivers are available at www.keithley.com.

Specifications

Voltage Specifications ^{1, 2}

Range	Max. Current	Source			Measure ³		
		Resolution	Accuracy (23° ± 5°C) 1 Year ±(% setting + volts)	Noise (RMS) (<10 Hz)	Resolution	Input Resistance	Accuracy (23° ± 5°C) 1 Year ±(% rdg. + volts)
200.0000 mV	7.35 A	5 µV	0.015% + 200 µV	1 µV	100 nV	>10 GΩ	0.012% + 200 µV
2.000000 V	7.35 A	50 µV	0.015% + 300 µV	10 µV	1 µV	>10 GΩ	0.012% + 300 µV
7.000000 V	7.35 A	250 µV	0.015% + 2.4 mV	100 µV	1 µV	>10 GΩ	0.015% + 1 mV
10.00000 V	5.25 A	500 µV	0.015% + 2.4 mV	100 µV	10 µV	>10 GΩ	0.015% + 1 mV
20.00000 V	4.20 A	500 µV	0.015% + 2.4 mV	100 µV	10 µV	>10 GΩ	0.015% + 1 mV
100.0000 V	1.05 A	2.5 mV	0.015% + 15 mV	1 mV	100 µV	>10 GΩ	0.015% + 5 mV

Current Specifications ^{1, 2, 5}

Range	Max. Voltage	Source			Measure ³		
		Resolution	Accuracy (23° ± 5°C) ⁴ 1 Year ±(% setting + amps)	Noise (RMS) (<10 Hz)	Resolution ⁴	Voltage Burden ⁶	Accuracy (23° ± 5°C) 1 Year ±(% rdg. + amps)
1.000000 µA	105 V	50 pA	0.025% + 1 nA	40 pA	10 pA	<100 µV	0.025% + 700 pA
10.00000 µA	105 V	500 pA	0.025% + 1.5 nA	40 pA	10 pA	<100 µV	0.025% + 1 nA
100.0000 µA	105 V	5 nA	0.020% + 15 nA	100 pA	100 pA	<100 µV	0.020% + 10 nA
1.000000 mA	105 V	50 nA	0.020% + 150 nA	1 nA	1 nA	<100 µV	0.020% + 100 nA
10.00000 mA	105 V	500 nA	0.020% + 1.5 µA	10 nA	10 nA	<100 µV	0.020% + 1 µA
100.0000 mA	105 V	5 µA	0.020% + 15 µA	100 nA	100 nA	<100 µV	0.020% + 10 µA
1.000000 A	105 V	50 µA	0.050% + 750 µA	5 µA	1 µA	<100 µV	0.050% + 500 µA
4.000000 A	21 V	250 µA	0.100% + 3 mA	25 µA	1 µA	<100 µV	0.100% + 2.5 mA
5.000000 A	10.5 V	250 µA	0.100% + 3 mA	25 µA	1 µA	<100 µV	0.100% + 2.5 mA
7.000000 A	7.35 V	500 µA	0.150% + 6 mA	125 µA	1 µA	<100 µV	0.150% + 5 mA

Temperature Coefficient (0°–18°C and 28°–50°C)

±(0.10 × accuracy specification)/°C.

Notes

- Speed = 1 PLC.
- All specifications are guaranteed with output ON.
- Accuracies apply to 2- and 4-wire mode when properly zeroed.
- 6.5-digit measure resolution.
- Accuracy specifications guaranteed when using 2460-KIT screw terminal accessory.
- Four-wire mode.

Resistance Measurement Accuracy (Local or Remote Sense) ^{1, 2, 3}

Range	Default Resolution ⁴	Default Test Current	Normal Accuracy (23°C ±5°C) 1 Year, ±(% rdg. + ohms)	Enhanced Accuracy ⁵ (23°C ±5°C) 1 Year, ±(% rdg. + ohms)
<2.000000 Ω ⁶	1 μΩ	User defined	Source I _{ACC} + Meas. V _{ACC}	Meas. I _{ACC} + Meas. V _{ACC}
20.00000 Ω	10 μΩ	100 mA	0.05% + 0.003 Ω	0.04% + 0.001 Ω
200.0000 Ω	100 μΩ	10 mA	0.05% + 0.03 Ω	0.04% + 0.01 Ω
2.000000 kΩ	1 mΩ	1 mA	0.05% + 0.3 Ω	0.04% + 0.1 Ω
20.00000 kΩ	10 mΩ	100 μA	0.05% + 3 Ω	0.04% + 1 Ω
200.0000 kΩ	100 mΩ	10 μA	0.05% + 30 Ω	0.05% + 10 Ω
2.000000 MΩ	1 Ω	10 μA	0.06% + 100 Ω	0.06% + 50 Ω
20.00000 MΩ	10 Ω	1 μA	0.14% + 1000 Ω	0.12% + 500 Ω
>20.0000 MΩ ⁶	—	User defined	Source I _{ACC} + Meas. V _{ACC}	Meas. I _{ACC} + Meas. V _{ACC}

Temperature Coefficient (0°–18°C and 28°–50°C)

±(0.10 × accuracy specification)/°C.

Source Current,

Measure Resistance Mode

Total uncertainty = I_{source} accuracy + V_{measure} accuracy (4-wire remote sense).

Source Voltage,

Measure Resistance Mode

Total uncertainty = V_{source} accuracy + I_{measure} accuracy (4-wire remote sense).

Guard Output Impedance

0.5 Ω (DC) in ohms mode.

Notes

- Speed = 1 PLC.
- All specifications are guaranteed with output ON.
- Accuracies apply to 2- and 4-wire mode when properly zeroed.
- 6.5-digit measure resolution.
- Source readback enabled. Offset compensation ON.
- Source current, measure resistance or source voltage, measure resistance only.

Supplemental Characteristics

Max. Output Power

100 W, four-quadrant source or sink operation.

Source Limits

V_{source}: ±7.35 V (≤7 A range), ±10.5 V (≤5 A range), ±21 V (≤4 A range), ±105 V (≤1 A range).
I_{source}: ±7.35 A (≤7 V range), ±5.25 mA (≤10 V range), ±4.2 A (≤20 V range), ±1.05 mA (≤100 V range).

Overrange

105% of range, source and measure.

Regulation

Voltage: Line: 0.01% of range. Load: 0.01% of range + 100 μV.
Current: Line: 0.01% of range. Load: 0.01% of range + 100 pA.

Source Limits

Voltage Source Current Limit: Bipolar current limit set with single value. Min. 10% of range.
Current Source Voltage Limit: Bipolar voltage limit set with single value. Min. 10% of range.

V-Limit / I-Limit Accuracy

Add 0.3% of setting and ±0.02% of reading to base specification.

Overshoot

Voltage Source: <0.1% typical (full scale step, resistive load, 20 V range, 10 mA I-Limit).
Current Source: <0.1% typical (1 mA step, R_{Load} = 10 kΩ, 20 V range).

Range Change Overshoot

Overshoot into a fully resistive 100 kΩ load, 10 Hz to 20 MHz BW, adjacent ranges: <250 mV typical.

Output Settling Time

Time required to reach 0.1% of final value, 20 V range, 100 mA I-Limit: <200 μs typical.

Maximum Slew Rate

1 V per μs, 100 V range, 100 mA limit into a 20 kΩ load (typical). 0.6 V per μs, 20 V range, 100 mA limit into a 20 kΩ load (typical).

Over Voltage Protection

User selectable values, 5% ±0.5 V tolerance. Factory default = none.

Voltage Source Noise

10Hz–20MHz (RMS): <4.5 mV typical into a resistive load.

Common Mode Voltage

250V DC.

Common Mode Isolation

>1G Ω, <1000 pF.

Noise Rejection (typical)

NPLC	NMRR	CMRR
0.01	—	60 dB
0.1	—	60 dB
1	60 dB	100 dB

Load Impedance**Normal Mode:** 20 nF typical.**High Capacitance Mode:** Stable into 50 μ F typical. High-C mode valid for ≥ 100 μ A ranges.**Max. Voltage Drop Between Force and Sense Terminals**

5 V.

Max. Sense Lead Resistance1 M Ω for rated accuracy.**Sense Input Impedance**>10 G Ω .**Guard Offset Voltage**<300 μ V, typical**System Measurement Speeds ¹****Reading Rates (readings/second) typical for 60 Hz (50 Hz), script (TSP®) programmed**

NPLC	Trigger Origin	Measure to Memory	Measure to GPIB/USB/LAN	Source-Measure to Memory	Source-Measure to GPIB/USB/LAN
0.01	Internal	3050 (2800)	2800 (2500)	1700 (1600)	1650 (1550)
0.01	External	2300 (2100)	2150 (2000)	1650 (1550)	1600 (1450)
0.1	Internal	540 (460)	530 (450)	470 (410)	470 (400)
0.1	External	500 (420)	500 (420)	460 (390)	450 (350)
1.00	Internal	59 (49)	59 (49)	58 (48)	58 (48)
1.00	External	58 (48)	58 (48)	57 (48)	57 (46)

Reading Rates (readings/second) typical for 60 Hz (50 Hz), SCPI programmed

NPLC	Trigger Origin	Measure to Memory	Measure to GPIB/USB/LAN	Source-Measure to Memory	Source-Measure to GPIB/USB/LAN
0.01	Internal	3000 (2800)	3000 (2790)	1700 (1600)	1550 (1500)
0.01	External	2330 (2150)	2330 (2150)	1650 (1550)	1500 (1450)
0.1	Internal	540 (460)	540 (460)	470 (410)	460 (400)
0.1	External	510 (430)	510 (430)	470 (400)	460 (390)
1.00	Internal	59 (49)	59 (49)	58 (48)	58 (48)
1.00	External	58 (49)	58 (49)	58 (48)	58 (48)

Notes

1. Reading rates applicable for voltage or current measurements, autozero off, autorange off, filter off, binary reading format, and source readback off.

Supplied Accessories

2460-KIT	Rear Panel Mating Mass Terminated Screw Connector
8608	High Performance Test Leads
USB-B-1	USB Cable, Type A to Type B, 1m (3.3 ft)
CS-1616-3	Safety Interlock Mating Connector
CA-180-3A	TSP-Link/Ethernet Cable
	Documentation CD
	2460 QuickStart Guide
	Test Script Builder Software (available at www.keithley.com)
	KickStart Startup Software (available at www.keithley.com)
	LabVIEW and IVI Drivers (available at www.keithley.com)

Available Accessories

Test Leads and Probes

1754	2-wire Universal 10-Piece Test Lead Kit
5805	Kelvin (4-Wire) Spring-Loaded Probes
5808	Low Cost Single-pin Kelvin Probe Set
5809	Low Cost Kelvin Clip Lead Set
8605	High Performance Modular Test Leads
8606	High Performance Modular Probe Kit
8608	High Performance Clip Lead Set

Cables, Connectors, Adapters

2460-BAN	Screw Terminal Connector to Banana Cable
2460-KIT	Mating Mass Termination Connector
8607	2-Wire, 1000V Banana Cables, 1m (3.3 ft.)
CS-1616-3	Safety Interlock Mating Connector

Communication Interfaces & Cables

7007-1	Shielded GPIB Cable, 1 m (3.3 ft)
7007-2	Shielded GPIB Cable, 1 m (6.6 ft)
CA-180-3A	CAT5 Crossover Cable for TSP-Link/Ethernet
KPCI-488LPA	IEEE-488 Interface for PCI Bus
KUSB-488B	IEEE-488 USB-to-GPIB Interface Adapter
USB-B-1	USB Cable, Type A to Type B, 1 m (3.3 ft)

Triggering and Control

2450-TLINK	DB-9 to Trigger Link Connector Adapter.
8501-1	Trigger Link Cable, DIN-to-DIN, 1 m (3.3 ft)
8501-2	Trigger Link Cable, DIN-to-DIN, 2 m (6.6 ft)

Rack Mount Kits

4299-8	Single Fixed Rack Mount Kit
4299-9	Dual Fixed Rack Mount Kit
4299-10	Dual Fixed Rack Mount Kit. Mount one 2460 and one Series 26xxB
4299-11	Dual Fixed Rack Mount Kit. Mount one 2460 and one Series 2400, Series 2000, etc.
2450-BenchKit	Ears and Handle for 2460-NFP-RACK and 2460-RACK models

Software Options

2460-ECHEM	Electrochemical Test Suite (must be ordered with 2460)
------------	--

Available Services

2460-3Y-EW	1 Year Factory Warranty extended to 3 years from date of shipment
2460-5Y-EW	1 Year Factory Warranty extended to 5 years from date of shipment
C/2460-3Y-17025	KeithleyCare® 3 Year ISO 17025 Calibration Plan
C/2460-3Y-DATA	KeithleyCare 3 Year Calibration w/Data Plan
C/2460-3Y-STD	KeithleyCare 3 Year Std. Calibration Plan
C/2460-5Y-17025	KeithleyCare 5 Year ISO 17025 Calibration Plan
C/2460-5Y-DATA	KeithleyCare 5 Year Calibration w/Data Plan
C/2460-5Y-STD	KeithleyCare 5 Year Std. Calibration Plan
C/NEW DATA	Calibration Data for New Units
C/NEW DATA ISO	ISO-17025 Calibration Data for New Units

General Characteristics (default mode unless specified)

Factory Default Standard Power-Up	SCPI Mode.
Source Output Modes	Fixed DC Level, Memory/Configuration List (mixed function), Sweep (linear and logarithmic), Sweep (dual linear and dual logarithmic).
Memory Buffer	>250,000 readings. Includes selected measured value(s) and time stamp.
Real-Time Clock	Lithium battery backup (3 yr. + battery life).
Remote Interfaces	
 GPIB	IEEE-488.1 compliant. Supports IEEE-488.2 common commands and status model topology.
 USB Device (rear panel, type B)	2.0 Full Speed USBTMC.
 USB Host (front panel, type A)	USB 2.0, support for flash drives, FAT32.
 Ethernet: RJ-45 (10/100BT)	
Digital I/O Interface	
 Lines	6 Input/Output user defined for digital I/O or triggering.
 Connector	9-pin female D.
 Input Signal Levels	0.7 V (maximum logic low), 3.7 V (minimum logic high).
 Input Voltage Limits	-0.25 V (Abs. minimum), +5.25 V (Abs. maximum).
 Maximum Source Current	+2.0 mA @ >2.7 V (per pin).
 Maximum Sink Current	-50 mA @ 0.7 V (per pin, solid-state fuse protected).
 5 V Power Supply Pin	Limited to 500 mA @ >4 V (solid-state fuse protected).
 Handler	User definable Start of Test, End of Test, 4 category bits.
Programmability	SCPI or TSP command sets.
TSP Mode	Embedded Test Script Processor (TSP) accessible from any host interface.
IP Configuration	Static or DHCP.
Expansion Interface	The TSP-Link expansion interface allows TSP enabled instruments to trigger and communicate with each other.
LXI Compliance	1.4 LXI Core 2011.
Display	5 inch capacitive touch, color TFT WVGA (800×480) with LED backlight.
Input Signal Connections	Front: Banana. Rear: Mass termination screw terminal.
Interlock	Active High Input.
Cooling	Forced air, variable speed.
Over Temperature Protection	Internally sensed temperature overload puts unit in standby mode.
Power Supply	100 V to 240 V RMS, 50–60 Hz (automatically detected at power up).
VA Rating	350 volt-amps max.
Altitude	Maximum 2000 meters above sea level.
EMC	Conforms to European Union EMC Directive.
Safety	Compliance with CE and NRTL listed to UL61010-1 and UL61010-2-30. Conforms with European Union Low Voltage Directive.
Vibration	MIL-PRF-28800F Class 3 Random.

Warm-Up	1 hour to rated accuracies.
Dimensions	With bumpers and handle: 106 mm high × 255 mm wide × 425 mm deep (4.18 in × 10.05 in × 16.75 in). Without bumpers and handle: 88 mm high × 213 mm wide × 403 mm deep (3.46 in × 8.39 in × 15.87 in.)
Weight	With bumpers and handle: 4.75 kg (10.5 lbs.). Without bumpers and handle: 4.35 kg (9.6 lbs.).
Environment	Operating: 0°–50°C, 70% R.H. up to 35°C. Derate 3% R.H./°C, 35°–50°C. Storage: –25°C to 65°C.
Accessories Supplied	Test Leads, Mating Mass Terminated Screw Connector, USB Cable, Ethernet/TSP Cable, Interlock Adapter, Power Cord, QuickStart Guide, CD User's Manual.

Ordering Information

2460	100 V, 7 A, 100 W SourceMeter Instrument
2460-NFP	100 V, 7 A, 100 W SourceMeter Instrument, with No Front Panel
2460-RACK	100 V, 7 A, 100 W SourceMeter Instrument, without Handle
2460-NFP-RACK	100 V, 7 A, 100 W SourceMeter Instrument, with No Front Panel and No Handle

Warranty Information

Warranty Summary	This section summarizes the warranties of the 2460. For complete warranty information, refer to the 2460 Reference Manual. Any portion of the product that is not manufactured by Keithley is not covered by this warranty and Keithley will have no duty to enforce any other manufacturer's warranties.
Hardware Warranty	Keithley Instruments, Inc. warrants the Keithley manufactured portion of the hardware for a period of one year from defects in materials or workmanship; provided that such defect has not been caused by use of the Keithley hardware which is not in accordance with the hardware instructions. The warranty does not apply upon any modification of Keithley hardware made by the customer or operation of the hardware outside the environmental specifications.
Software Warranty	Keithley warrants for the Keithley produced portion of the software or firmware will conform in all material respects with the published specifications for a period of ninety (90) days; provided the software is used on the product for which it is intended in accordance with the software instructions. Keithley does not warrant that operation of the software will be uninterrupted or error-free, or that the software will be adequate for the customer's intended application. The warranty does not apply upon any modification of the software made by the customer.

Contact Information:

Australia* 1 800 709 465
Austria 00800 2255 4835
Balkans, Israel, South Africa and other ISE Countries +41 52 675 3777
Belgium* 00800 2255 4835
Brazil +55 (11) 3759 7627
Canada 1 800 833 9200
Central East Europe / Baltics +41 52 675 3777
Central Europe / Greece +41 52 675 3777
Denmark +45 80 88 1401
Finland +41 52 675 3777
France* 00800 2255 4835
Germany* 00800 2255 4835
Hong Kong 400 820 5835
India 000 800 650 1835
Indonesia 007 803 601 5249
Italy 00800 2255 4835
Japan 81 (3) 6714 3010
Luxembourg +41 52 675 3777
Malaysia 1 800 22 55835
Mexico, Central/South America and Caribbean 52 (55) 56 04 50 90
Middle East, Asia, and North Africa +41 52 675 3777
The Netherlands* 00800 2255 4835
New Zealand 0800 800 238
Norway 800 16098
People's Republic of China 400 820 5835
Philippines 1 800 1601 0077
Poland +41 52 675 3777
Portugal 80 08 12370
Republic of Korea +82 2 6917 5000
Russia / CIS +7 (495) 6647564
Singapore 800 6011 473
South Africa +41 52 675 3777
Spain* 00800 2255 4835
Sweden* 00800 2255 4835
Switzerland* 00800 2255 4835
Taiwan 886 (2) 2656 6688
Thailand 1 800 011 931
United Kingdom / Ireland* 00800 2255 4835
USA 1 800 833 9200
Vietnam 12060128

* European toll-free number. If not accessible, call: +41 52 675 3777

For More Information:



Vicom Australia

1064 Centre Rd
Oakleigh South Vic
3167 Australia
1300 360 251
info@vicom.com.au
www.vicom.com.au

Vicom New Zealand

Grd Floor, 60 Grafton Road
Auckland 1010
New Zealand
+64 9 379 4596
info@vicom.co.nz
www.vicom.co.nz

Find more valuable resources at TEK.COM

